



SCALA2



<http://qr.grundfos.com/i/scala2install>

be
think
innovate

GRUNDFOS 

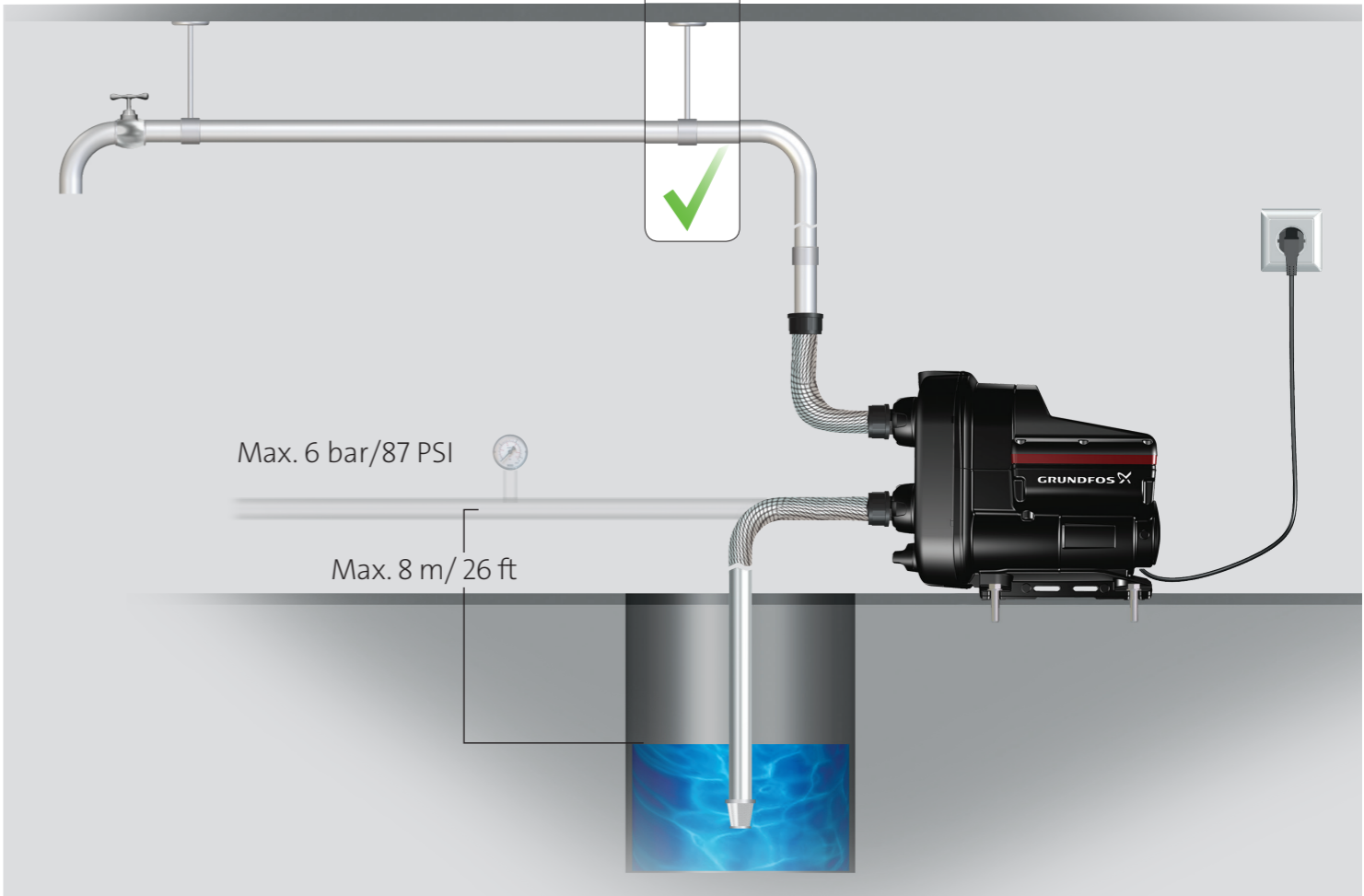
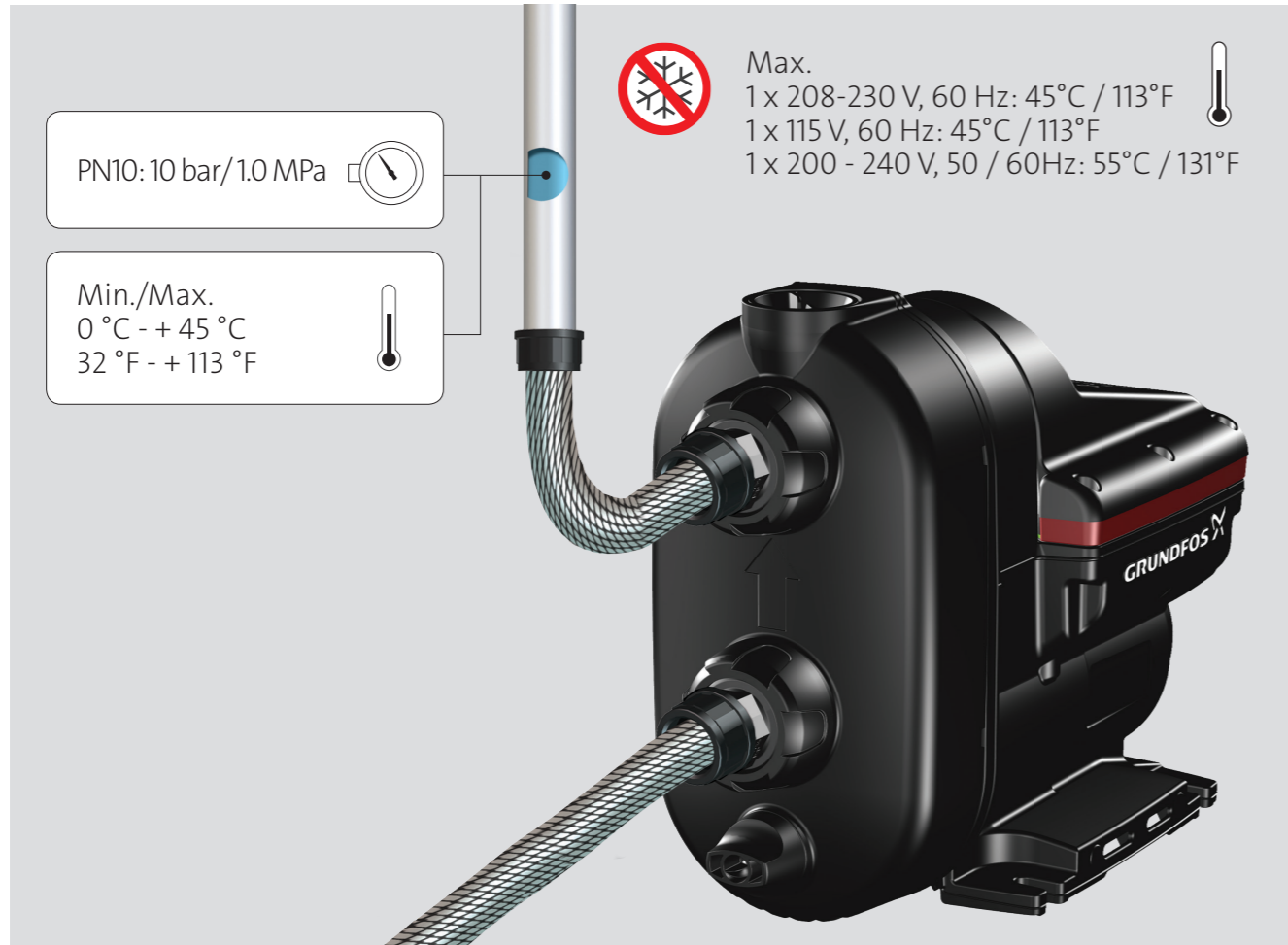
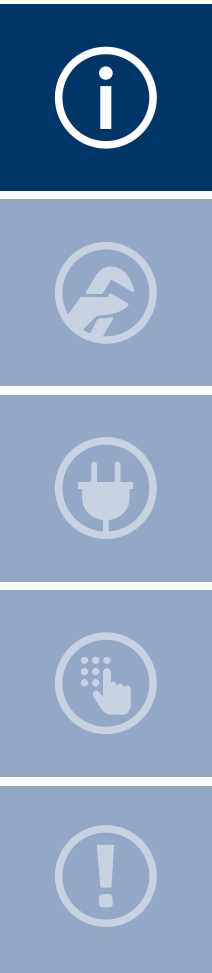

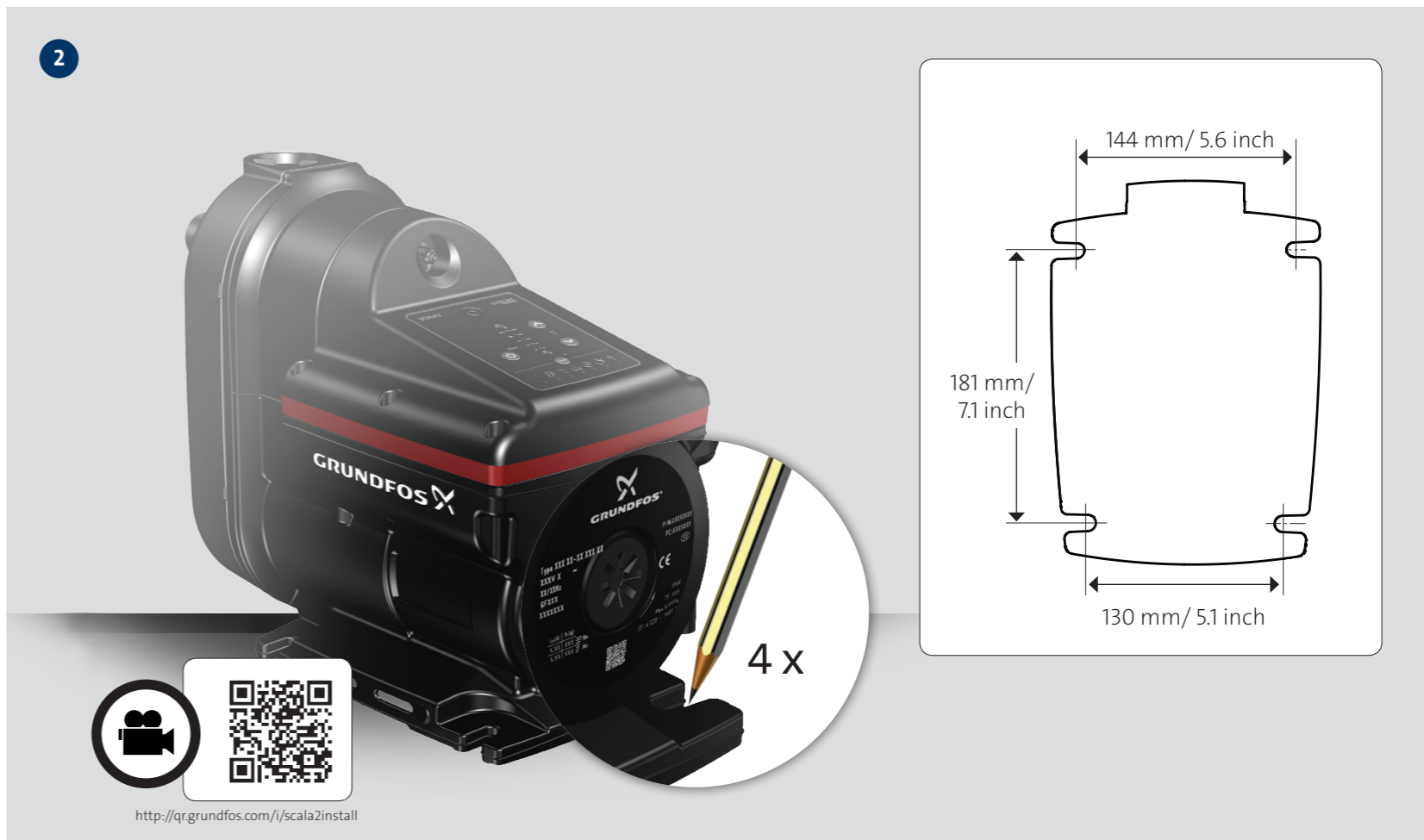
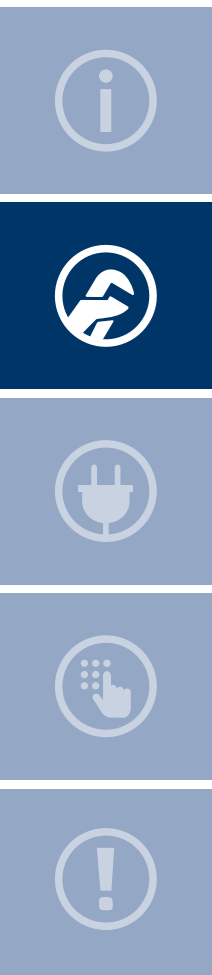

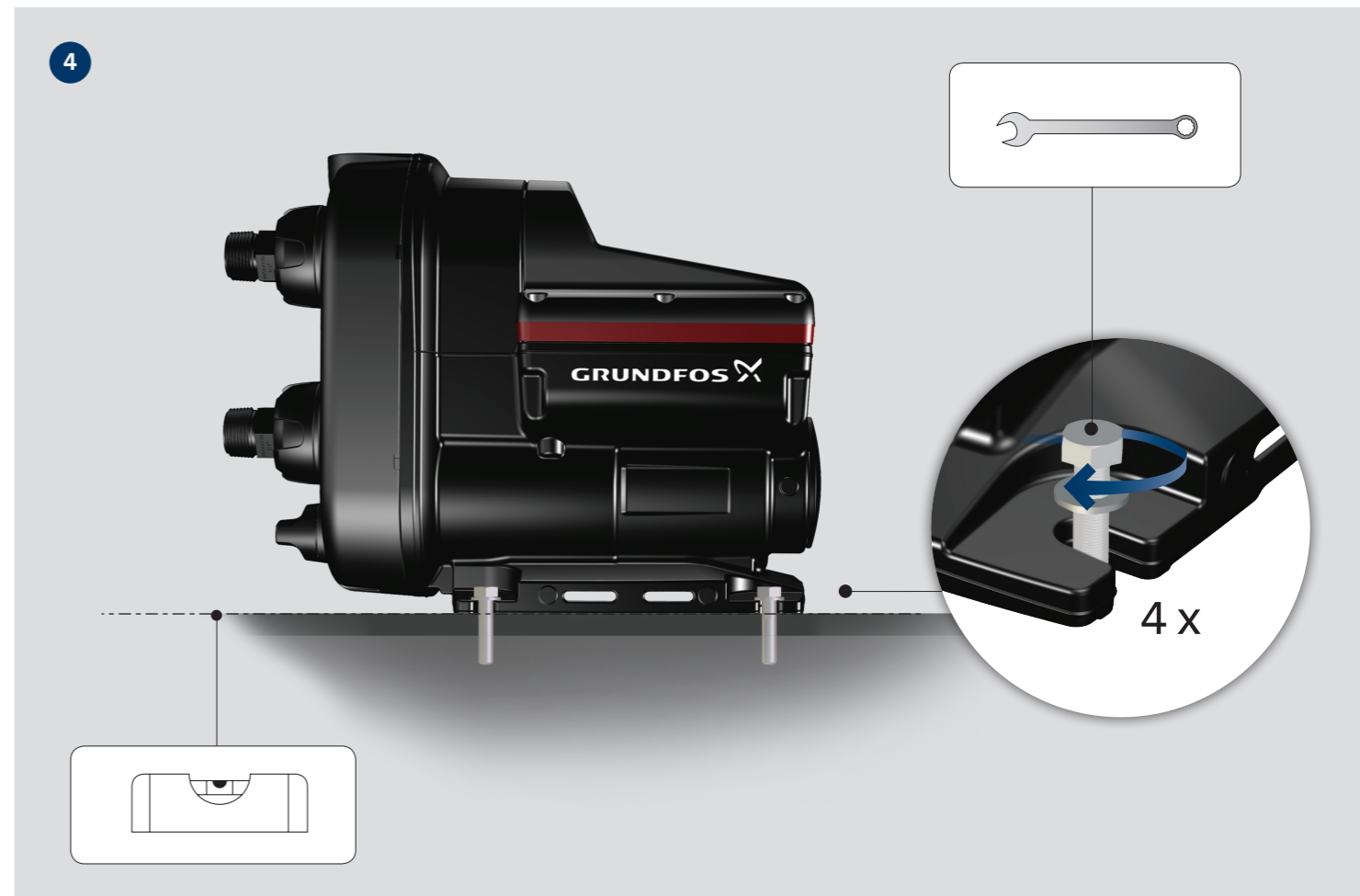
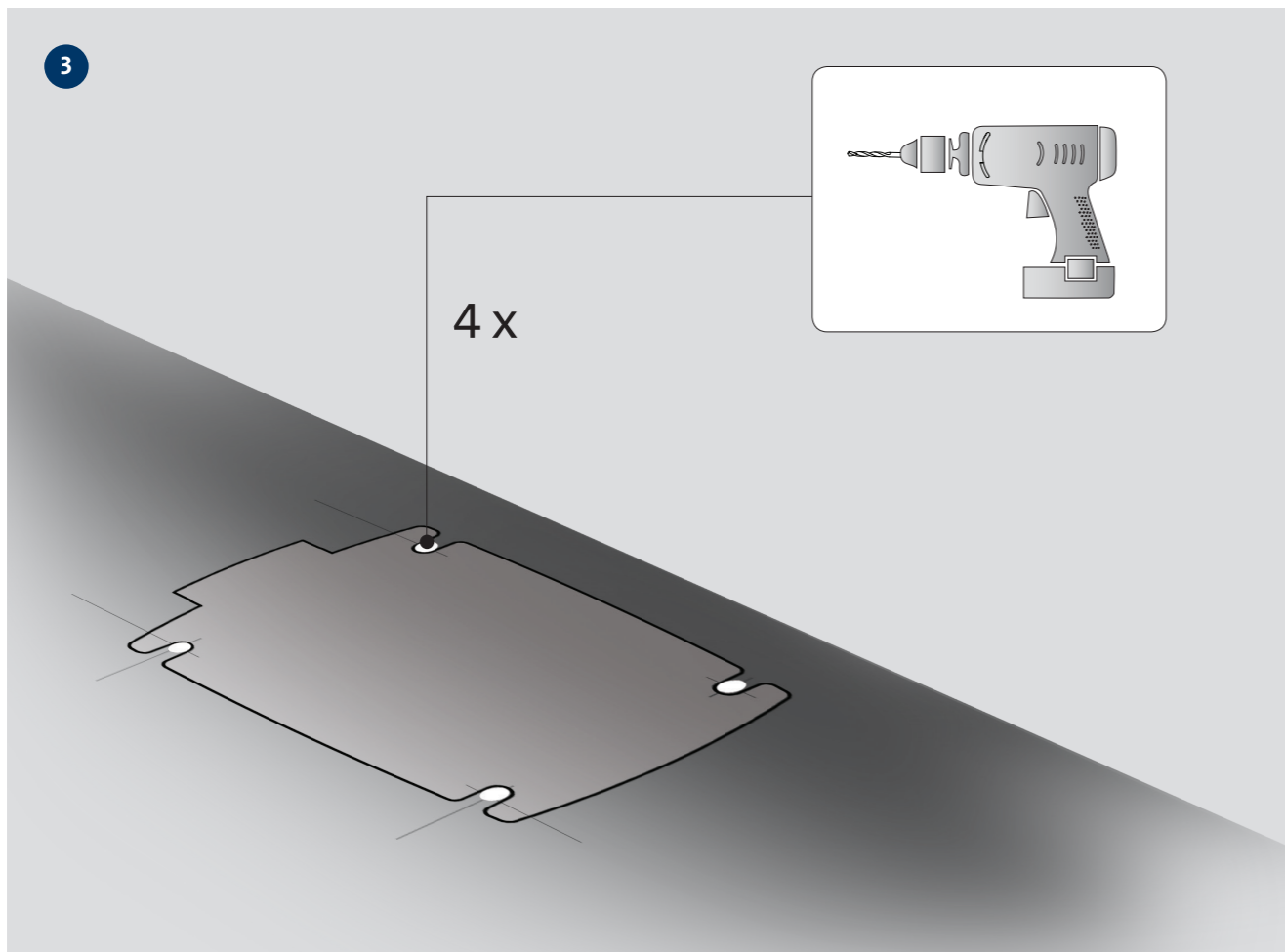
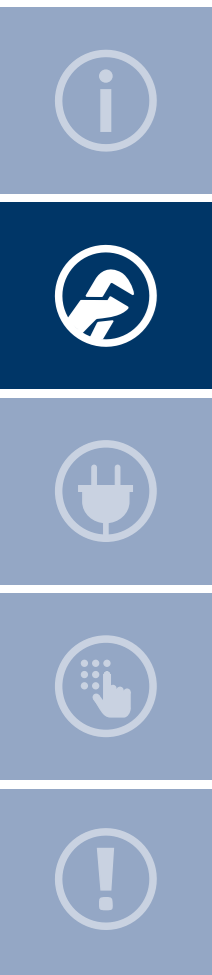

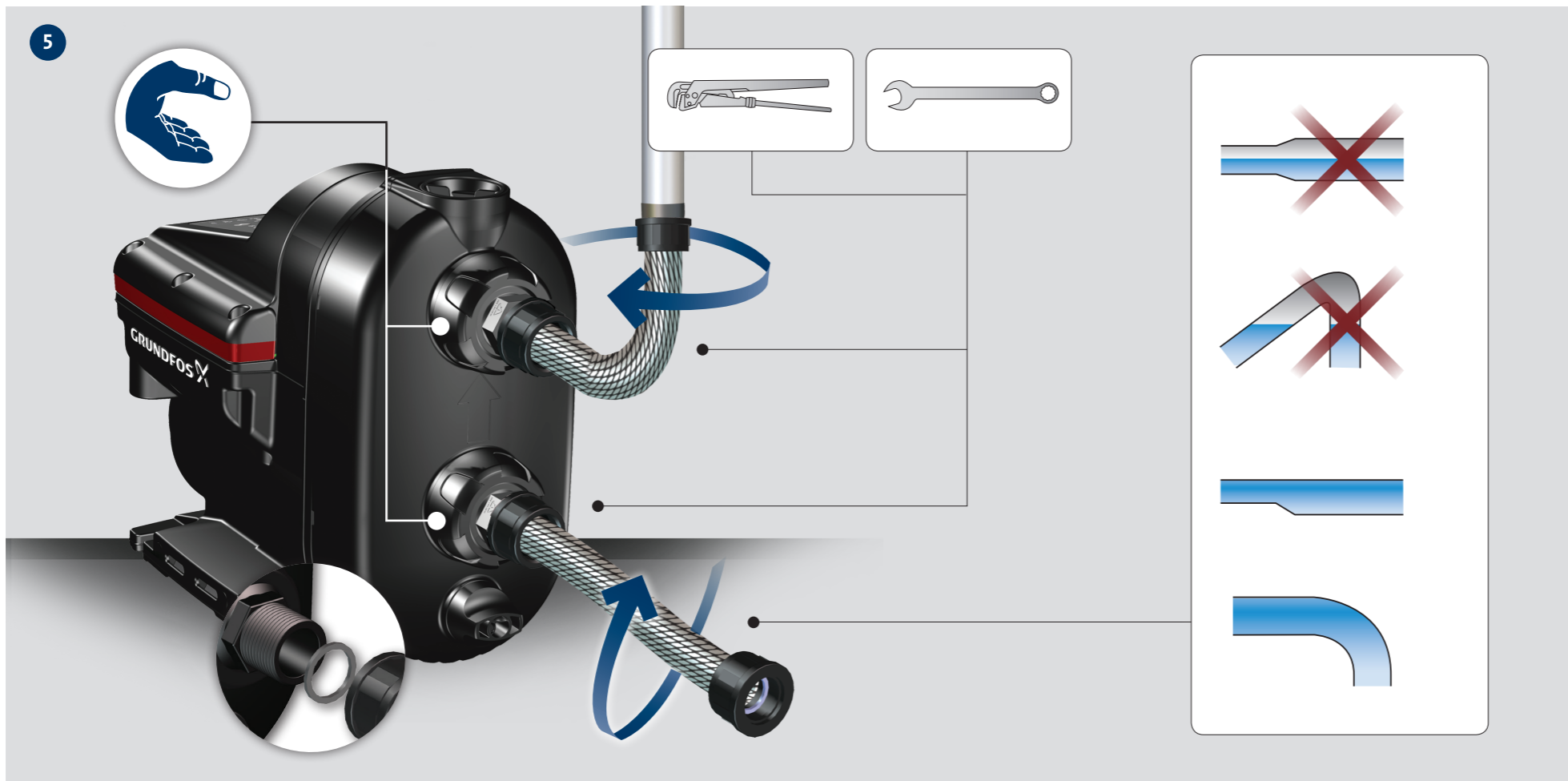
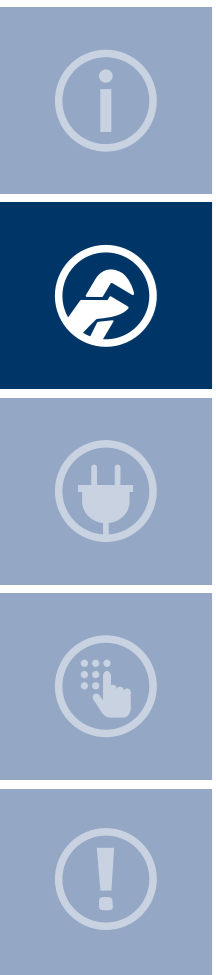

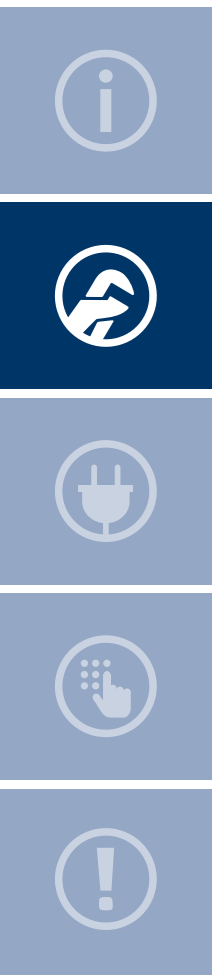

6



<http://qr.grundfos.com/i/scala2install>

7



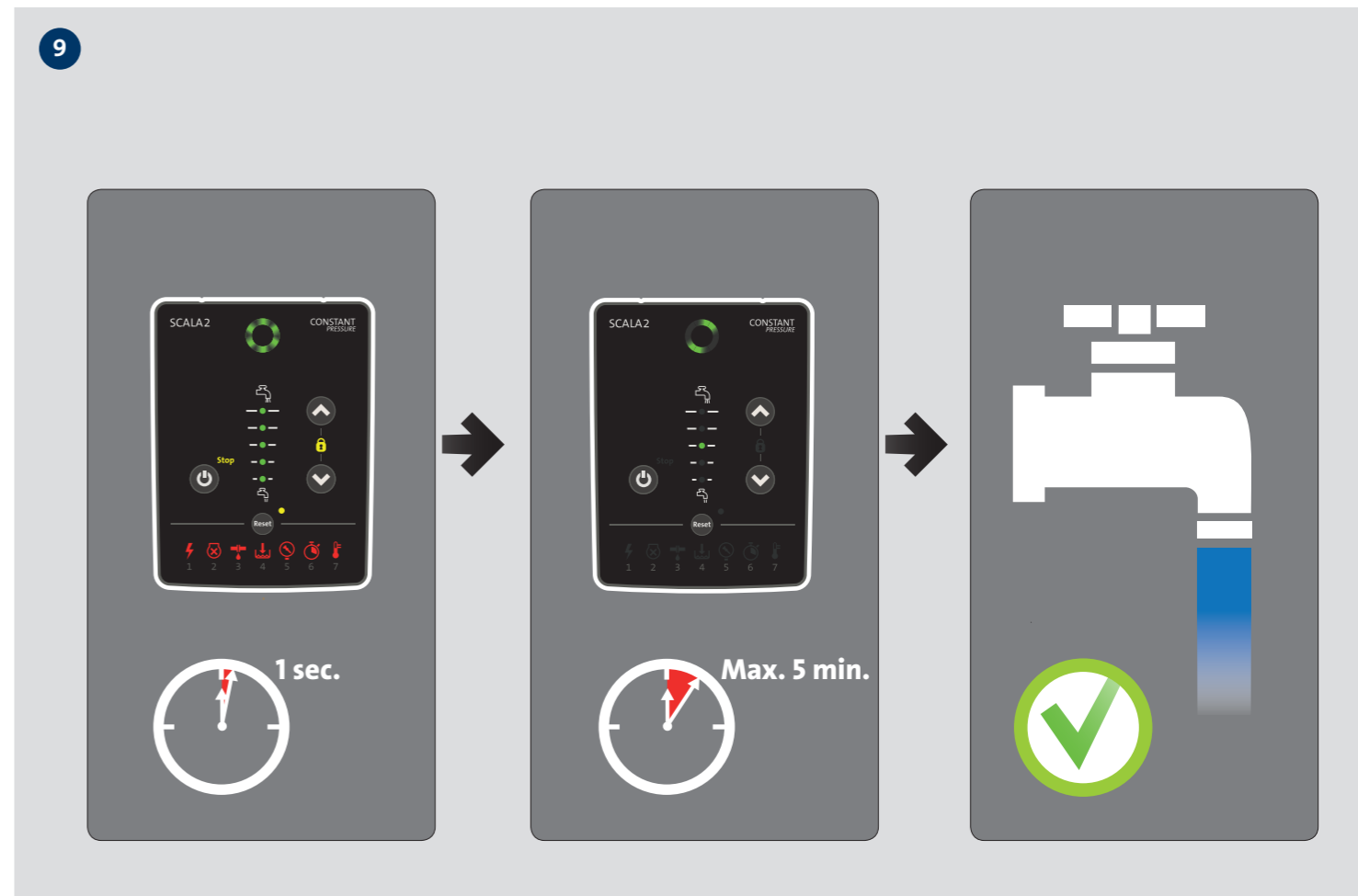
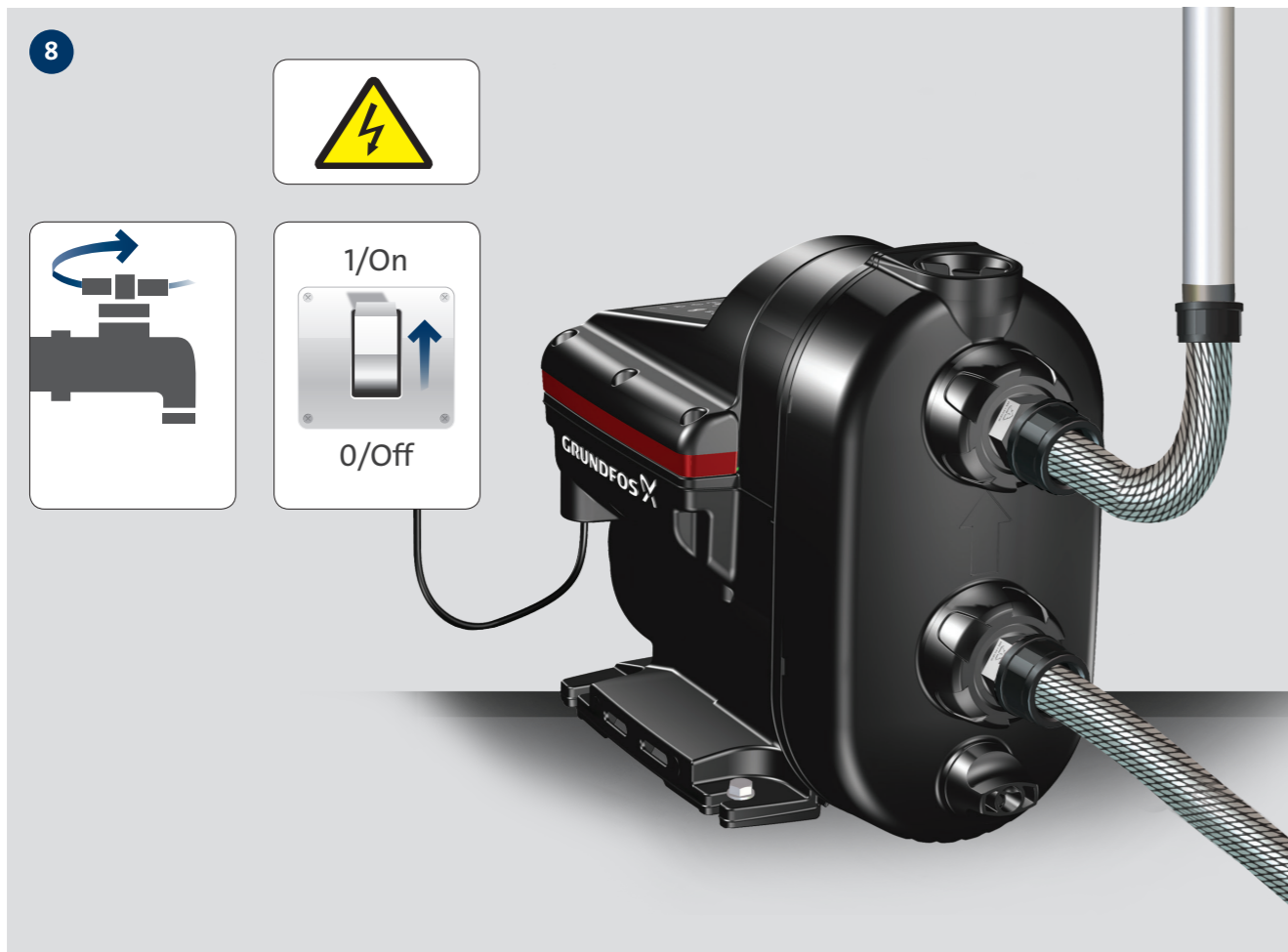
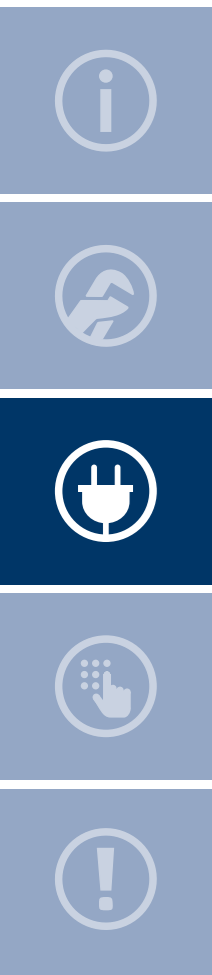

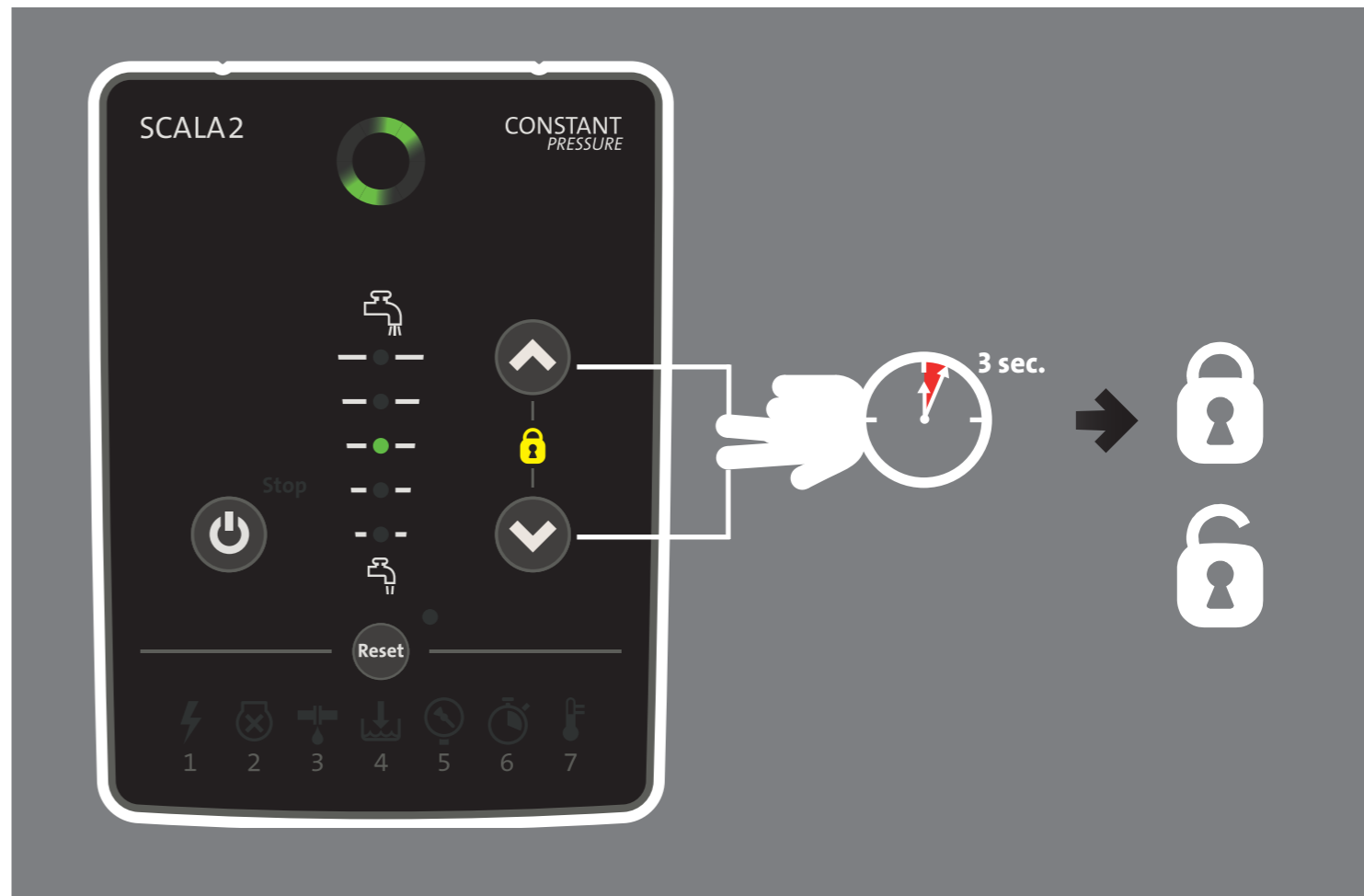
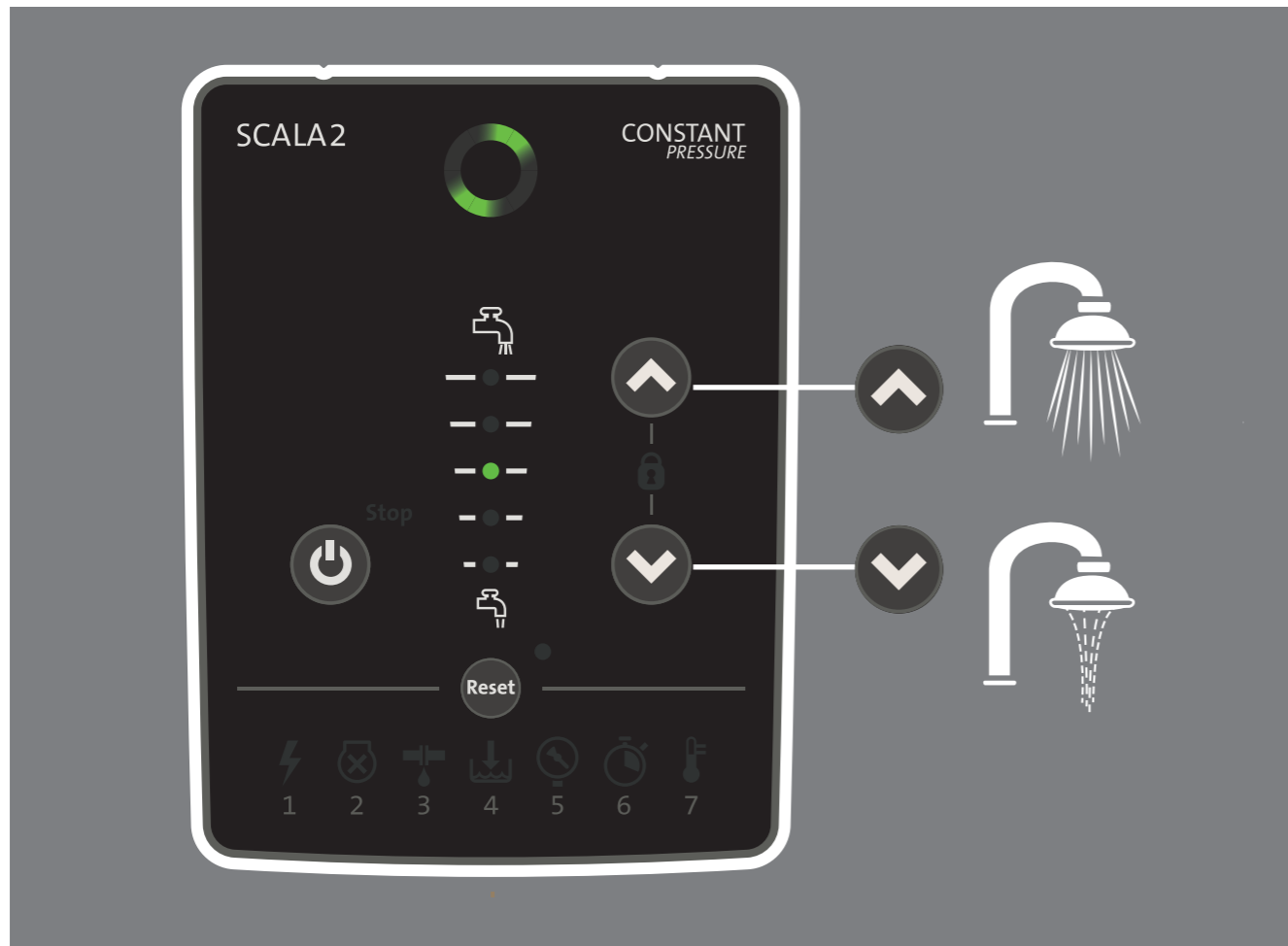
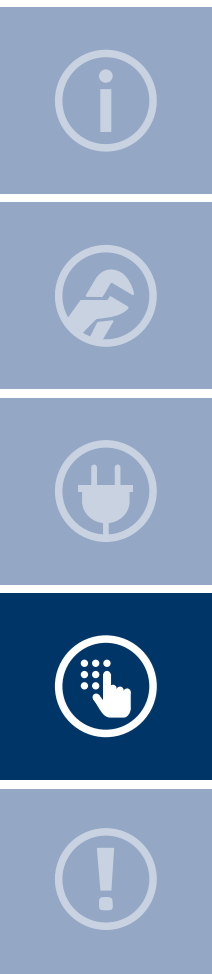

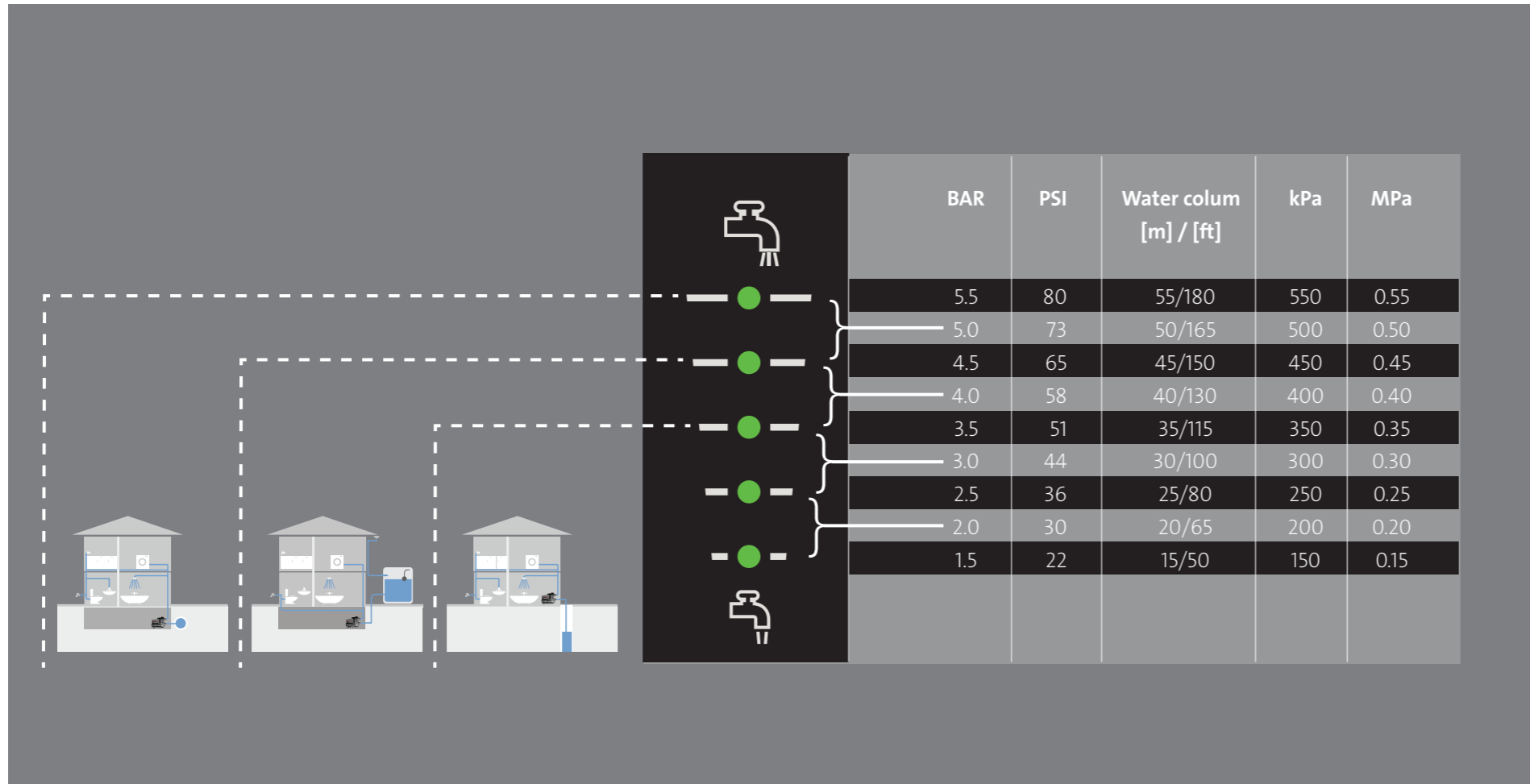
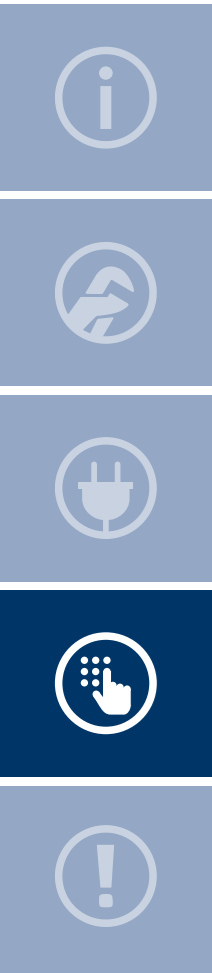

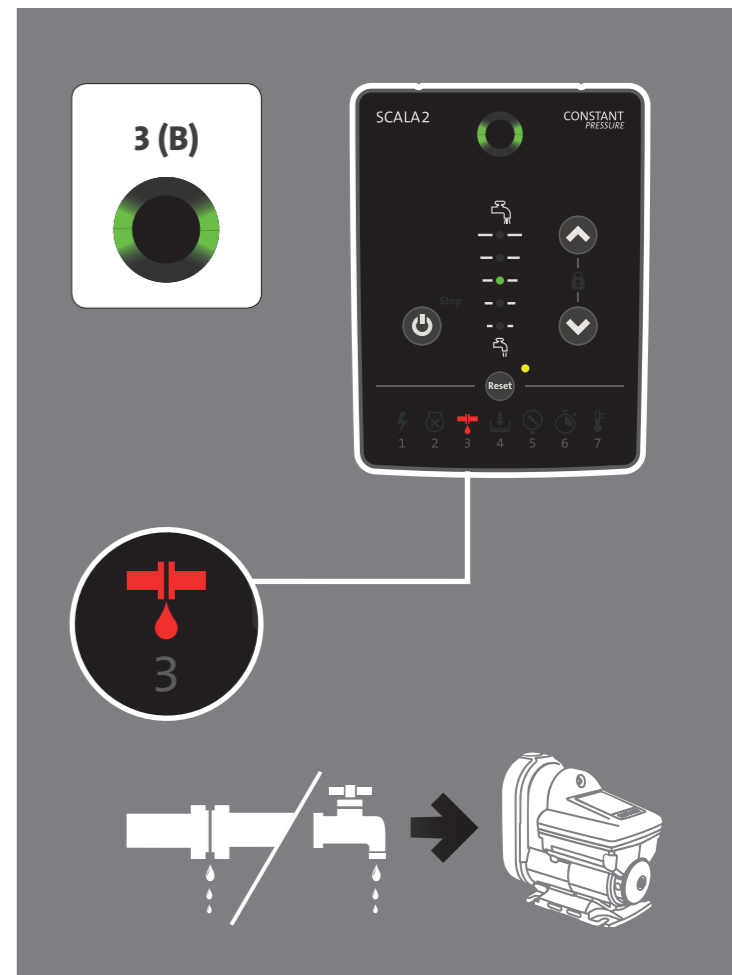
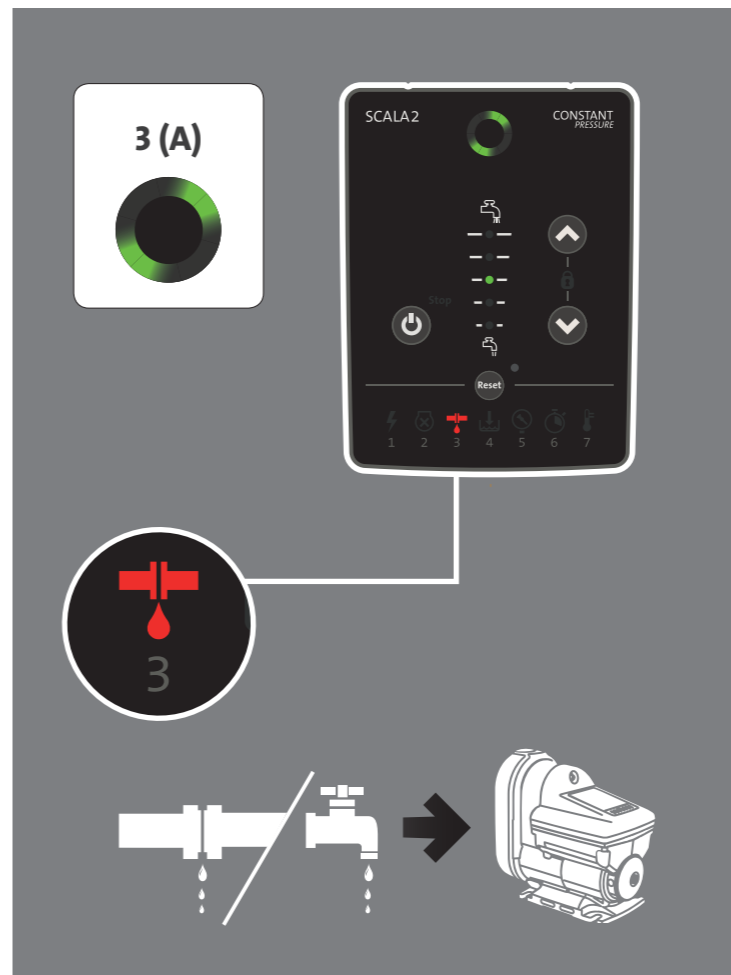
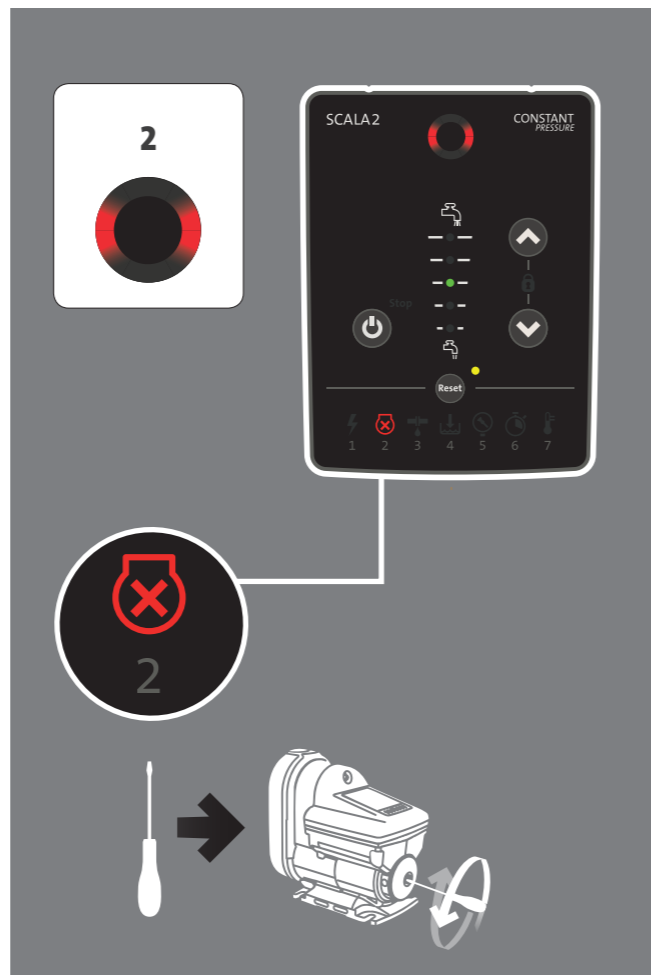
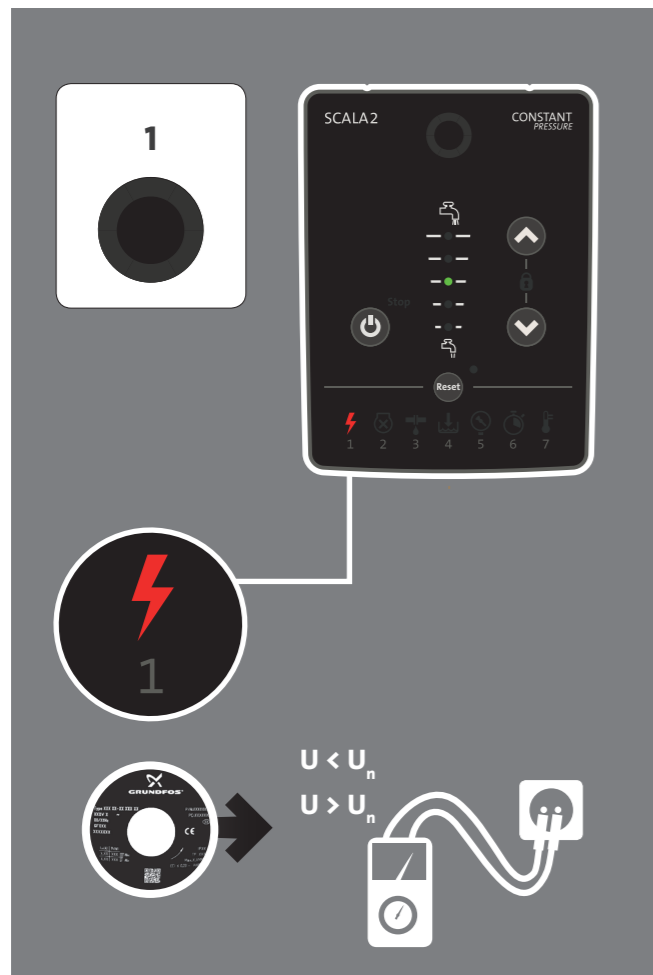
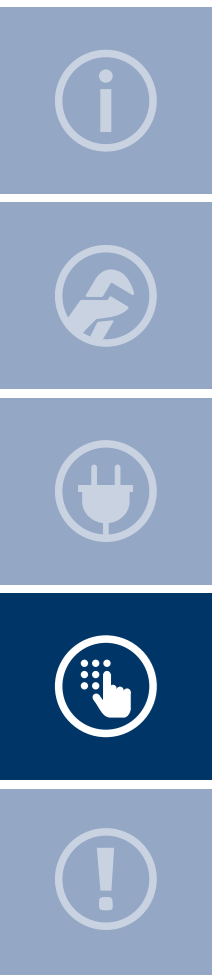

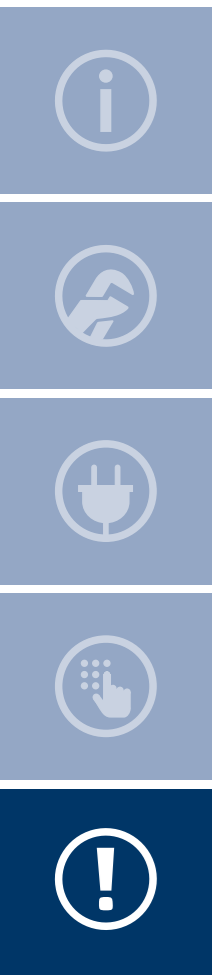

4

SCALA2 CONSTANT PRESSURE

4

1 2 3 4 5 6 7

5

SCALA2 CONSTANT PRESSURE

5

1 2 3 4 5 6 7

$p > p_{\text{syst. max.}}$

$P_{\text{set}} > H_{\text{max}}$

6

SCALA2 CONSTANT PRESSURE

6

1 2 3 4 5 6 7

0.5 hr.

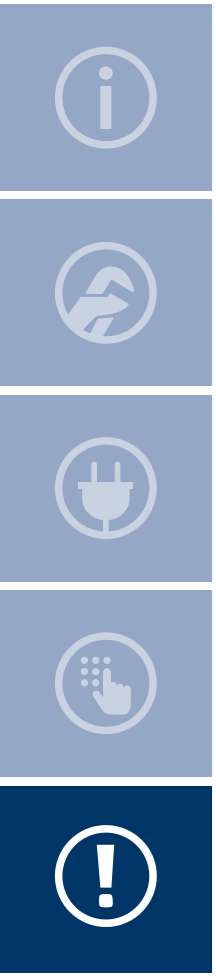

7 (A)

SCALA2 CONSTANT PRESSURE

7

7 (B)

SCALA2 CONSTANT PRESSURE

7

GRUNDFOS X

1 2 3 4 5 6 7

net.grundfos.com/qr/i/98880508

be think innovate

98501666 0416

ECM: 1183347

GRUNDFOS Holding A/S
Poul Due Jensens Vej 7
DK-8850 Bjerringbro
Tel: +45 87 50 14 00
www.grundfos.com

GRUNDFOS 

The name Grundfos, the Grundfos logo, and be think innovate are registered trademarks owned by Grundfos Holding A/S or Grundfos A/S, Denmark. All rights reserved worldwide.